

**HOROW®**

**Installation & User Manual**

# **HOROW** T30 Series

**Bidet Toilet**

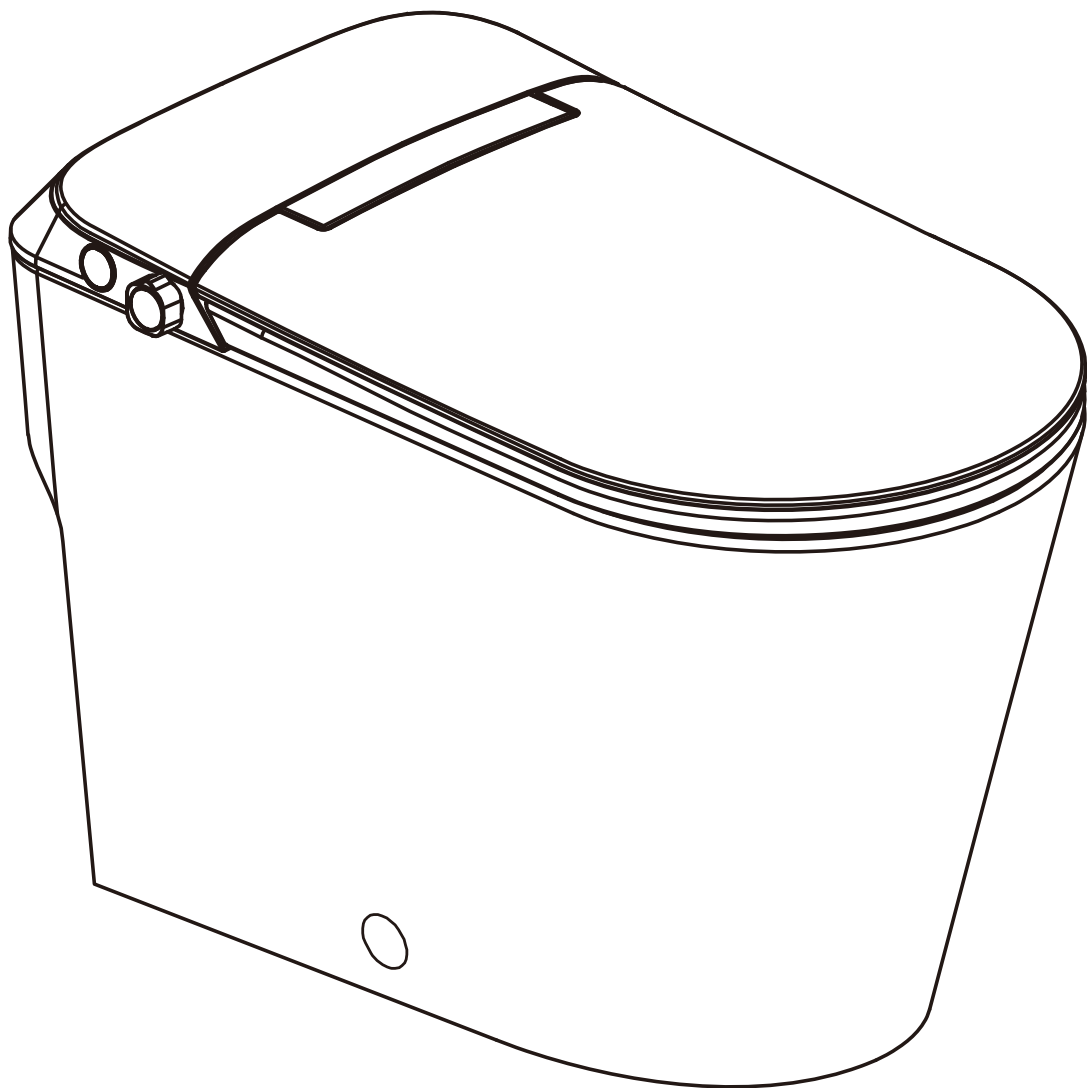

# Contents

<b>Important Information</b> .....	1
<b>Overall Sketch</b> .....	2
<b>Function Table</b> .....	2
<b>Product Installation</b> .....	3
Tools Needed for Installation .....	3
Parts Included .....	3
Prior to Installation .....	4
Installation of Bidet Toilet .....	5
Product Test Run .....	8
<b>Usage Instructions</b> .....	9
Knob Operations .....	9
Flush Button Operations .....	10
Kick Control Operations .....	10
<b>Daily Maintenance</b> .....	11
Maintenance of Ceramics, Seat and Lid .....	11
Maintenance of the Nozzle .....	12
Maintenance During Winter Season .....	12
<b>Troubleshooting</b> .....	13
<b>Specifications</b> .....	13
<b>Warranty</b> .....	14

- Thank You for Choosing HOROW. Please read the instructions carefully before installation and keep it available for future maintenance or reference.
- We are not responsible for the accidents resulting from the user's negligence.
- HOROW reserves the right to make revisions to this manual without notice.



**Need help? Contact HOROW Customer Service Team.**

**Phone: (+1)209-200-8033**

**Monday to Friday**

**Email: [support@horow.com](mailto:support@horow.com)**

## Important Information



1. Two people are required to handle and install this product as it is fragile.
2. Please read this manual carefully before installation. Always use the appropriate tools and always wear appropriate personal safety accessories to protect your safety.
3. The limited warranty is void for any commercial installation.
4. We are not responsible for local code compliance for this product. Building and plumbing codes may vary from state to state by location. We are not responsible for providing any compliance certifications.
5. We are not responsible for providing any type of certification for this product.
6. Under no circumstances shall we be liable for any incidental damages sustained in connection with this product.

## Overall Sketch

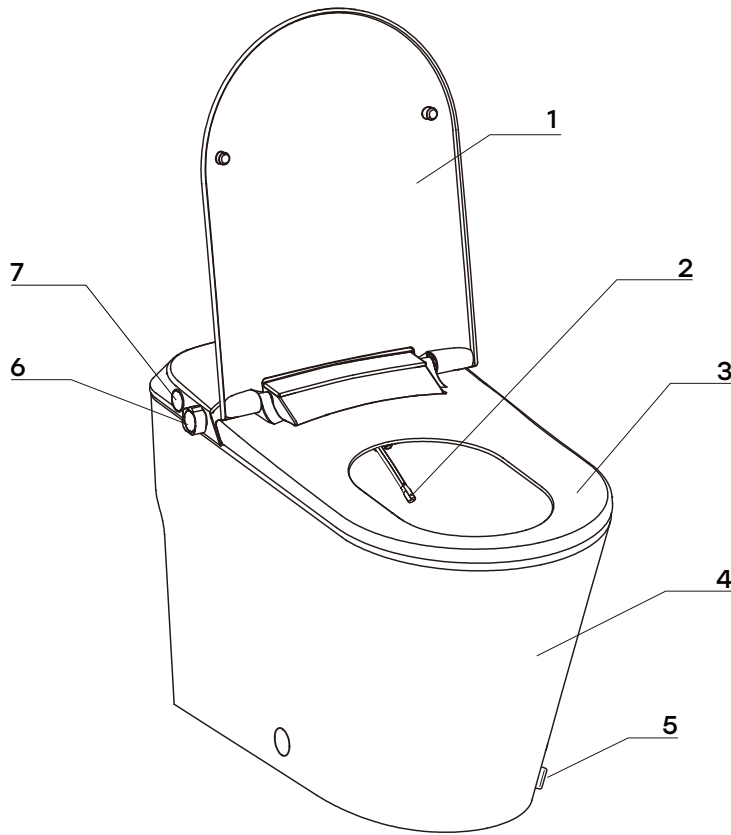

1	Lid
2	Nozzle
3	Seat
4	Ceramic Toilet Bowl
5	Kick Control
6	Knob
7	Flush Button

## Function Table

Category	Model	T30 Series
<b>Hygiene</b>	Feminine Wash	●
	Posterior Wash	●
	Self-cleaning Nozzle	●
	Anti-bacterial Seat	●
	Easy-clean Glaze	●
<b>Comfort</b>	ADA Height	●
<b>Convenience</b>	Kick Flush	●
	Soft Close	●
<b>Safety</b>	Air Isolation & Backflow Prevention	●

Note:

No electricity is required for this bidet toilet, and it only provides cold water wash.

# Product Installation





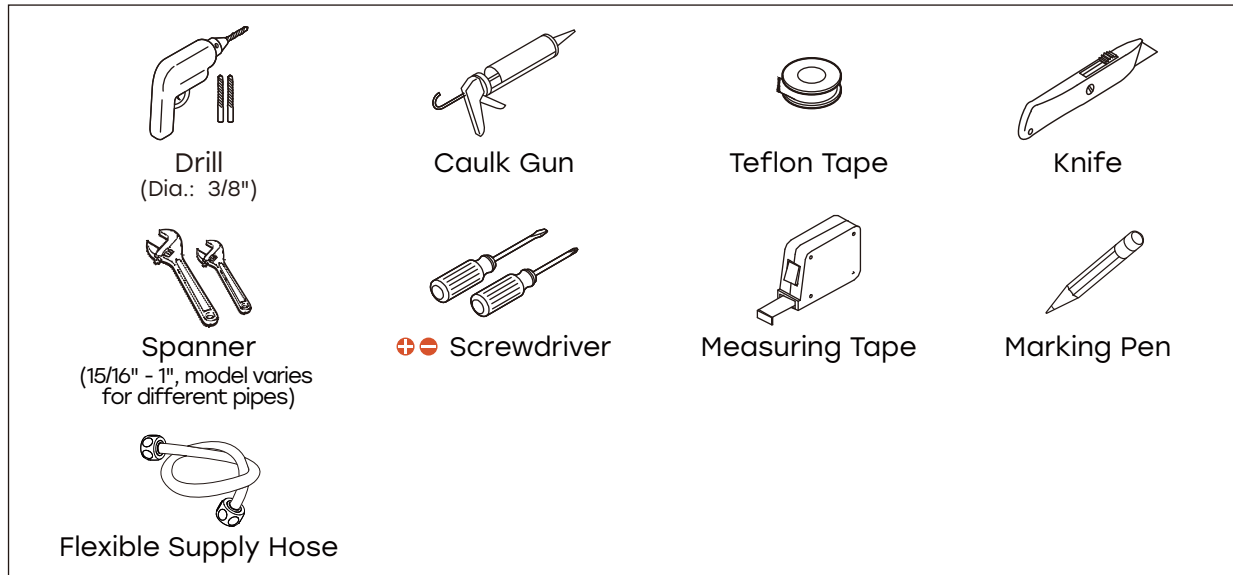





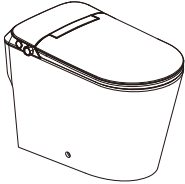

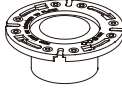
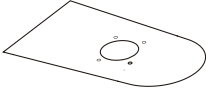
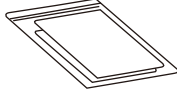

















## Tools Needed for Installation

Please have these tools prepared prior to installation.



## Parts Included

Please confirm that all items below are inside the box.

<p>Bidet Toilet (1 pc)</p> 	<p>Wax Ring (1 pc)</p> 	<p>Floor Flange (1 pc)</p> 									
<p>Installation Template (1 pc)</p> 	<p>Installation &amp; User Manual</p> 	<p>Adapter (1 pc)</p>  <p>G1/2 Adapter</p>									
<p>Mounting Accessory Kit:</p> <table border="0"> <tr> <td data-bbox="236 1832 571 1877">  Expansion Bolt (4 pcs)         </td> <td data-bbox="644 1832 858 1877">  Screw (4 pcs)         </td> <td data-bbox="1034 1832 1321 1877">  Toilet Screw (2 pcs)         </td> </tr> <tr> <td data-bbox="236 1899 571 1944">  Mounting Block (2 pcs)         </td> <td data-bbox="644 1899 858 1944">  Bolt (2 pcs)         </td> <td data-bbox="1034 1899 1321 1944">  Metal Washer (2 pcs)         </td> </tr> <tr> <td data-bbox="236 1966 427 2011">  Nut (2 pcs)         </td> <td data-bbox="644 1966 970 2011">  Plastic Washer (2 pcs)         </td> <td data-bbox="1034 1966 1369 2011">  Decorative Cap (2 pcs)         </td> </tr> </table>			 Expansion Bolt (4 pcs)	 Screw (4 pcs)	 Toilet Screw (2 pcs)	 Mounting Block (2 pcs)	 Bolt (2 pcs)	 Metal Washer (2 pcs)	 Nut (2 pcs)	 Plastic Washer (2 pcs)	 Decorative Cap (2 pcs)
 Expansion Bolt (4 pcs)	 Screw (4 pcs)	 Toilet Screw (2 pcs)									
 Mounting Block (2 pcs)	 Bolt (2 pcs)	 Metal Washer (2 pcs)									
 Nut (2 pcs)	 Plastic Washer (2 pcs)	 Decorative Cap (2 pcs)									

## Prior to Installation

Please confirm that all the aforementioned items in the package are present. In case of any missing parts, please feel free to contact our Customer Service Team. Illustrations above are for reference only. The ceramic product may have slight deformation during the firing process. Please consult the actual product for accurate details.

Verify the product dimensions and secure enough installation space. The rough-in size refers to the distance between the center of the toilet flange to the finished back wall.

※ All dimensions are manually measured with a certain degree of error. For the specific size, please refer to the actual product received.

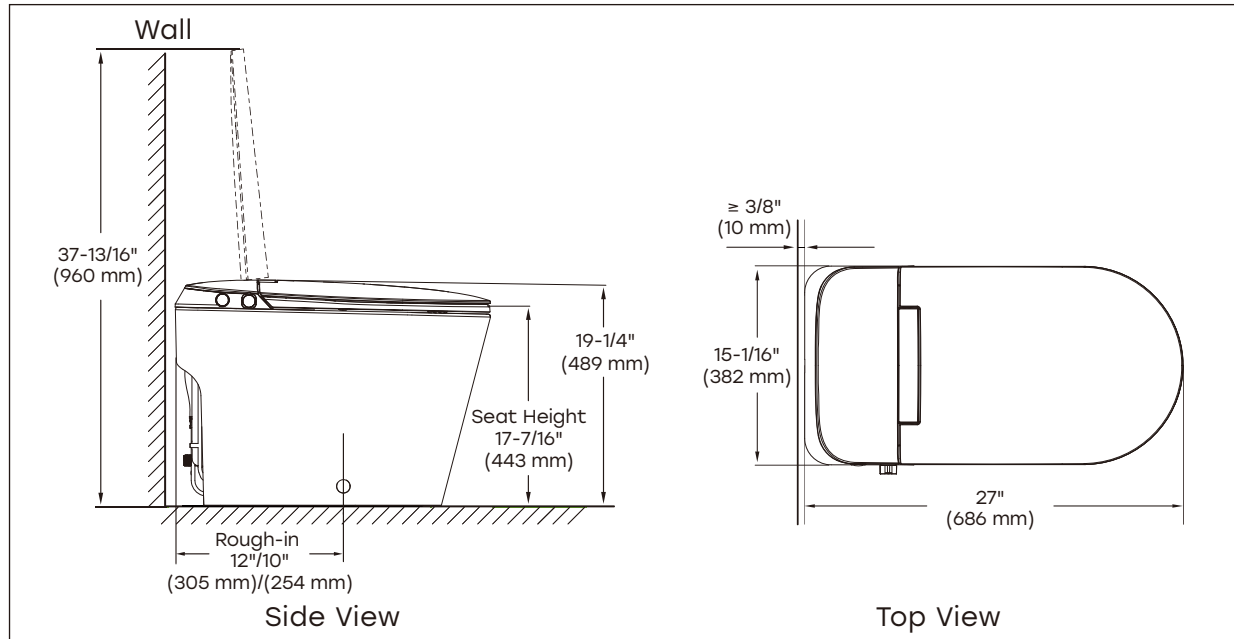

To ensure proper installation, the distance between the water supply valve and the centerline of the toilet should be greater than half the width of the toilet bottom. The water supply valve should be about 8-1/2" (216 mm) away from the toilet centerline. For larger valves, a greater distance may be necessary to ensure proper clearance. For easy installation and maintenance, a range of 9" (229 mm) to 11" (279 mm) is recommended.

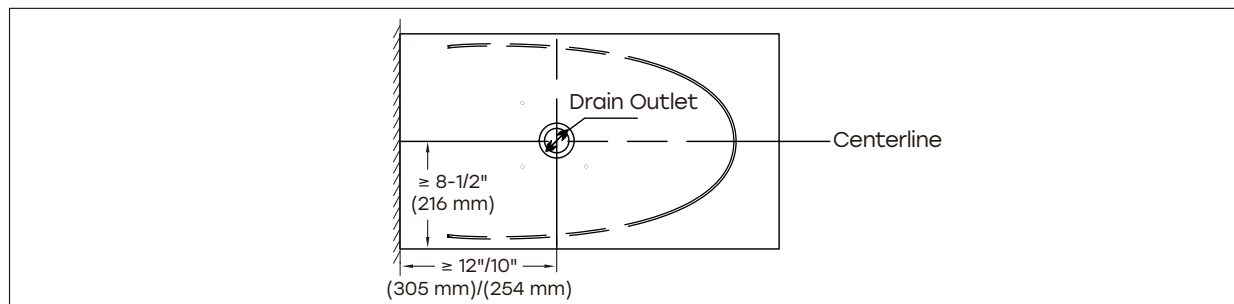

The minimum water pressure required is 15 psi, and the maximum water pressure is 125 psi. If the minimum water pressure is not met, the bidet toilet may not achieve the optimal cleaning performance.

To use the bidet functions, make sure that the water temperature is between 39.2 °F to 95 °F and that the bathroom temperature is above 39.2 °F.

The product has undergone a water supply test before delivery. Therefore, it is normal that a few water drops flow out of it when it is being taken out of the package.

## Installation of Bidet Toilet

Install your toilet using the following steps:

Please remove the old toilet first if any and ensure the mounting surface is clean and level before the new toilet is installed.

### 1 Open the box right side up

Remove the accessories first, then lift the toilet with two people, remove the packaging, and gently place the toilet on the floor, as shown in the diagrams below.

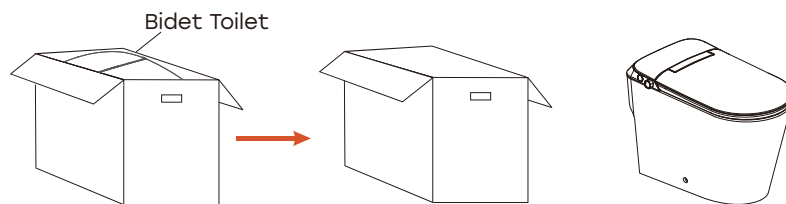

### 2 Connect water hose to toilet tank

Connect the flexible water hose (not included) to the toilet tank. Select the adapter based on actual requirement. Tighten the coupling nuts by 1/4 turn beyond hand tight.

Note:

1. Please connect the hose to the toilet tank inlet beforehand, as it will be difficult to do so after the toilet is installed.
2. Our toilet fits both 7/8" and G1/2 water hoses. If your water hose is 7/8", you can directly connect it to the toilet. If your water hose is G1/2, please screw on the adapter first, then connect the hose.
3. Do not overtighten the nut on the tank connection. It may cause water leakage.

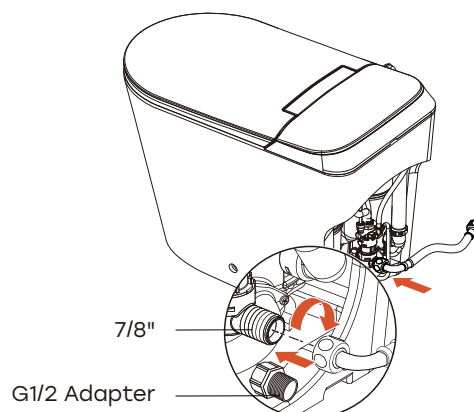

**3 Install with installation template**

Align the installation template with the centerline of drain outlet. Mark four mounting holes based on the installation template with the marking pen. Then, outline the edges of the template to mark the toilet placement for later installation and remove the installation template.

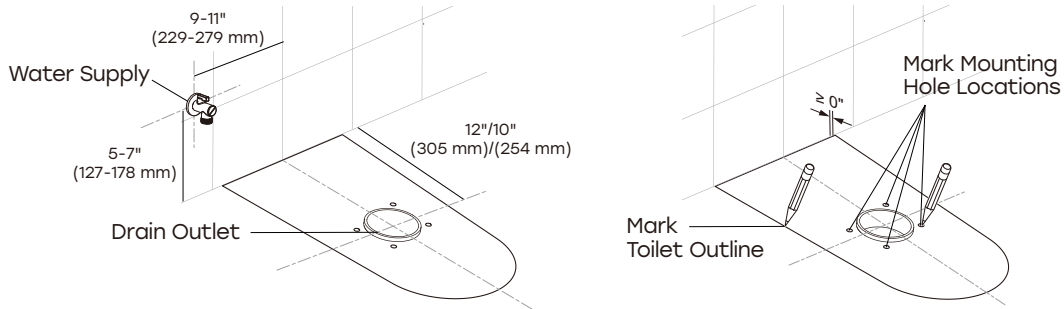

**4 Install and fix the flange**

Drill four 3/8" (10 mm) holes at the marked locations (about 1-9/16" (40 mm) deep). Insert four expansion bolts into the holes. Position the flange on the drain outlet, aligning the four flange holes with the drilled holes on the ground. Insert the screws into the flange holes and tighten them using a screwdriver.

- ※ Make sure the flange is not higher than the floor after installation.
- ※ If an applicable flange is already in place, there is no need to install the new one.

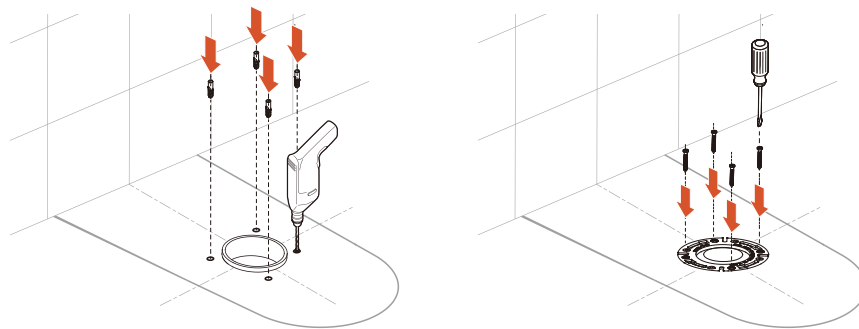

**5 Install the mounting blocks**

Install the bolts into the flange channels properly. Assemble the mounting blocks with bolts. Position the two mounting blocks on opposite sides of the flange on the ground and secure them with washers and nuts.

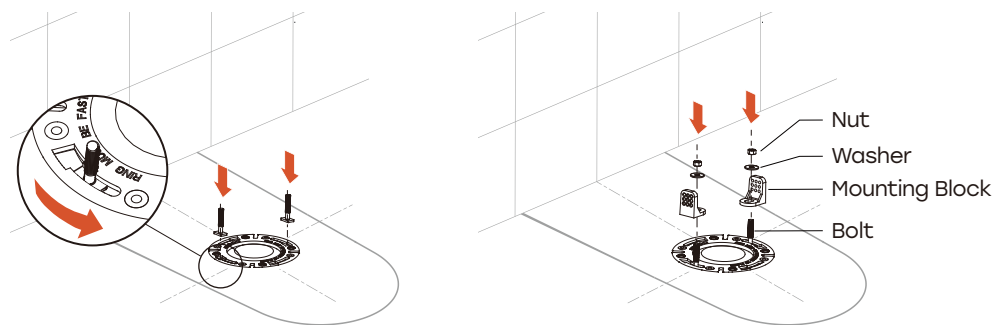

**6 Install the ceramic toilet**

Install the wax ring onto the drain hole at the bottom of the ceramic toilet and press it firmly into place.

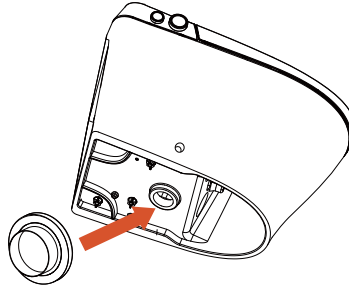

Lift the ceramic toilet with two people and gently lower it onto the drain outlet, letting it well fit the mounting blocks.

Press down firmly on the ceramic toilet to ensure the wax ring forms a complete seal.

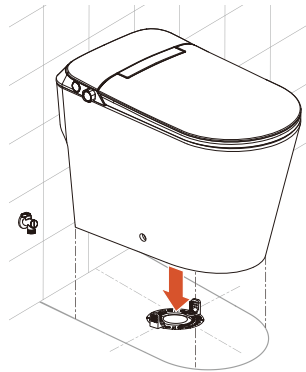

Insert the screws through the washers, then through the holes on both sides of the ceramic toilet and into the mounting blocks on the ground. Tighten them securely using a screwdriver.

Put the decorative caps onto the screw heads.

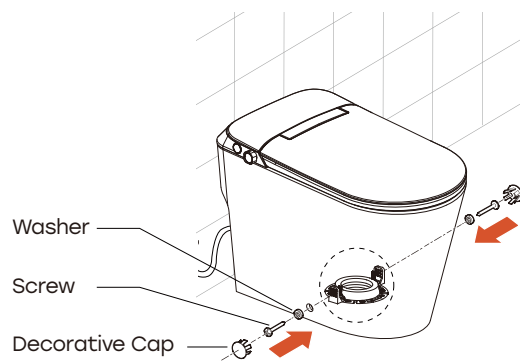

**Tips:**

- ※ The toilet is heavy, and it needs two people to carry it.
- ※ Please clean the drain outlet.
- ※ Please make sure ceramic toilet outlet sits perfectly on the drain outlet.

**7 Connect water hose to angle valve**

Connect the water hose to the angle valve. Tighten the coupling nuts by 1/4 turn beyond hand tight. Use Teflon tape on all threaded connections to ensure a water tight seal.

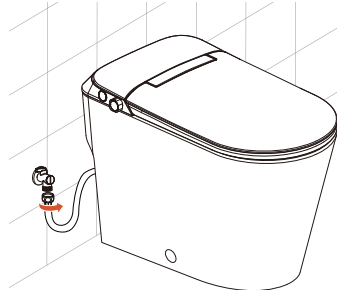
**Product Test Run****1 Water Connection**

Turn the water supply angle valve to the maximum opening, as shown in the diagram. Make sure no leakage is found at various connection parts.

※ In case of any water leakage, unfasten the nuts and install them again.

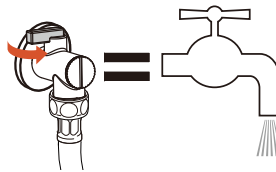
**2 Bidet Toilet Running**

Are all functions working properly?

Test the knob and the flush button on the toilet. Verify the normal operation of each function.

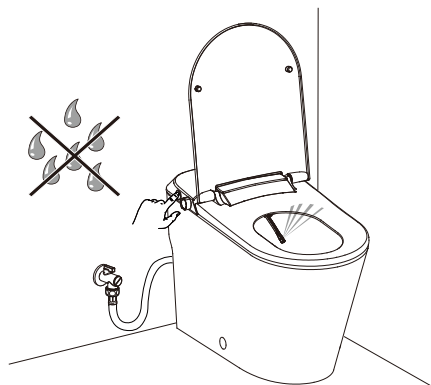

After the toilet is installed and the test run is completed, it is recommended that you apply the silicone sealant around the base of the toilet. Please avoid applying sealant where the access covers meet the floor.

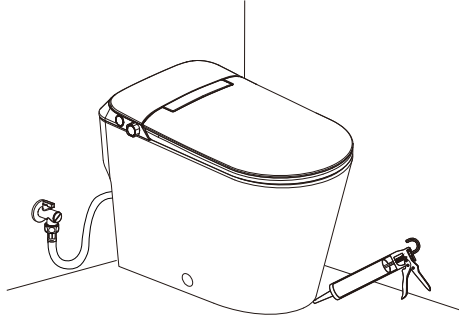

## Usage Instructions

### Function Explanations

**+**

**Posterior Wash**  
Rotate counterclockwise  
Rotate the knob counterclockwise to the first position to start nozzle self-cleaning, to the second position to extend the nozzle out and rotate further to start posterior wash.  
During a posterior wash, rotate the knob counterclockwise to increase the cleaning intensity, and clockwise to decrease it.

**Feminine Wash**  
Rotate clockwise  
Rotate the knob clockwise to the first position to start nozzle self-cleaning, to the second position to extend the nozzle out and rotate further to start the feminine wash.  
During a feminine wash, rotate the knob clockwise to increase the cleaning intensity, and counterclockwise to decrease it.

Note:  
The nozzle will remain retracted during the self-cleaning process.

## Flush Button Operations



Press the flush button  beside the knob to flush the toilet.



Flush Button

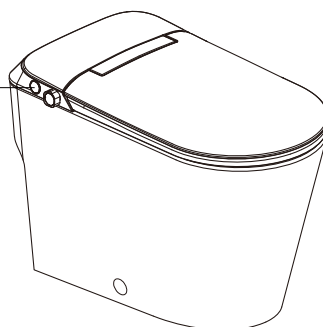

## Kick Control Operations



Tap the kick control on the ceramic body with your foot to flush the toilet.

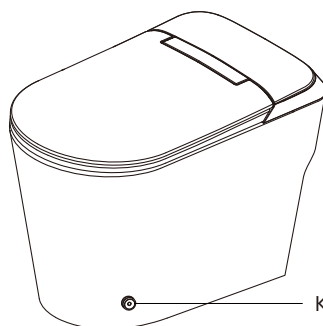

Kick Control

## Daily Maintenance

Regular maintenance is required to ensure normal use.

**Note:**

1. Cut off the water supply before maintenance.
2. Direct water wash to the entire product is prohibited.

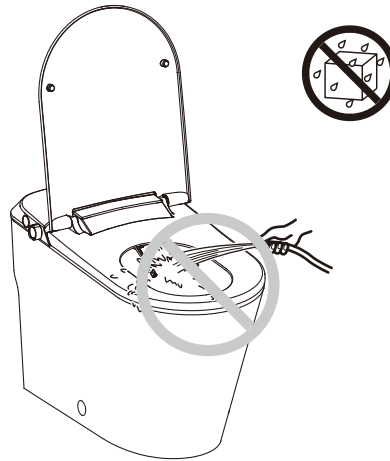

## Maintenance of Ceramics, Seat and Lid



1. Wipe dust or stains with a soft wet cloth.
2. A wet soft brush, cloth, or sponge may be used to clean the ceramic area.

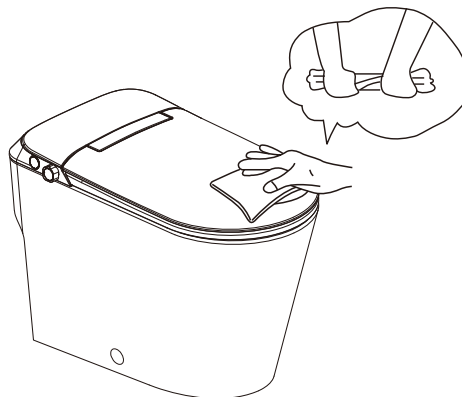

※ Do not use abrasive cleaners, such as alcohol, bleach, painter thinner, cresol, benzene, gasoline, etc.

## Maintenance of the Nozzle



Pull out the nozzle gently and pull it at least 5 times. Hold the nozzle gently and wipe it with a soft cloth, sponge or small brush using a mild detergent.

※ Do not forcefully hold the nozzle, otherwise it may break.

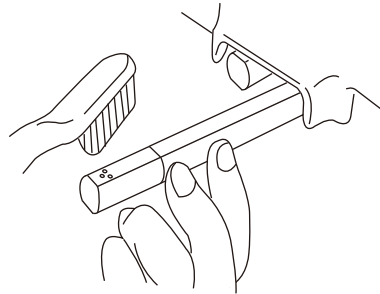

## Maintenance During Winter Season



Ensure the indoor temperature remains above 39.2 °F during use. If the indoor temperature falls below 39.2 °F, stop using the product and follow these steps:

1. Turn off the angle valve to stop the water supply.
2. Flush the toilet to drain the water from the tank.

Note:

Performing maintenance before draining the product may cause damage and leaks. If the product is moved from a cold environment to a warmer one, condensation may form inside. In such cases, let the product stand for a few hours before use.

# Troubleshooting

This Troubleshooting Guide is for general aid only. If the user encounters any problems, please first consult the troubleshooting guide below. If the problem persists, please contact our Customer Service Team.

Scan the QR code for video resources and find the troubleshooting videos you need.



Phenomenon	Fault Diagnoses	Solutions
Water leakage	Loose hose connector	Turn off the water supply switch and check whether the connector between it (or the product) and the hose is tightened.
Flushing failure	Abnormal water supply	Check whether the water supply switch is on and whether the filter is blocked.
Weak flushing power	Too low water supply pressure	Please make sure the water supply pressure is above 15 psi.
	Insufficient water in the tank	Please make sure the interval between two consecutive flushes is longer than 60 seconds.

# Specifications

Product Model		HOROW T30 Series
Product Dimensions		27" (L) * 15-1/16" (W) * 19-1/4" (H)
Product Weight (lb.)		86.95 lb
Rough In Size		12"/10"
Seat Height		17-7/16"
Bowl/Seat Shape		Elongated
Flush Type		Tornado flush
Gallons Per Flush (US gallon)		Single Flush: 1.0
Installation Type		Floor-mount
Water Inlet	Inlet Water Temperature	39.2 °F ~ 95 °F
	Minimum Pressure	15 psi, ensuring a flow of water at least 2.4 GPM
	Maximum Pressure	125 psi (static state)
Ambient Temperature		39.2 °F ~ 104 °F

# Warranty

## ONE YEAR LIMITED WARRANTY

HOROW products are made with high-quality materials and workmanship to provide customers with products that are built to last. If any defects in material or workmanship are detected during normal use within the first year of purchase, such as the replacement of any product or product part that you consider to be defective, HOROW will provide replacement parts free of charge. We are **not responsible** for all damages that result from **improper installation resulting in unavailability, repair and maintenance**. This warranty applies only to the original purchaser. Proof of purchase and **evidence of damage** will be required in the case of a **claim**.

HOROW recommends the installations to be made by a licensed, professional plumber.

HOROW will not be held responsible for any damage or product failure due to improper installation, misuse, or failure to use a licensed professional. HOROW is not responsible for any removal or installation cost.

This One Year Limited Warranty will be voided if:

The installation recommendations were not followed.

The product has been moved from its initial place of installation.

The product has been modified.

The product has been subjected to improper maintenance, abuse, misuse, excessive use of chemicals, accident or other damages.

HOROW makes no implication that products comply with any or all local building or plumbing codes. It is the consumer's responsibility to determine local code compliance. This warranty extends to the original purchaser and first consumer.

HOROW is not liable for any incidental, consequential or special damages associated with the return, replacement, installation or use of your product. This includes freight costs, labor, travel time, lost profit, home damages and other contingent liabilities and costs (including, without limitation, costs associated with experts, investigations, analyses, attorneys and other professionals and services).

The HOROW warranty is a comprehensive and explicit limit of liability, and all items outside of it are not addressable by or the responsibility of HOROW. Certain states have variances regarding implied warranties and in those situations, we remain fully compliant.

### Warranty Registration

Proof of purchase is required to validate this limited warranty. HOROW encourages you to register your product upon purchase to create a record of ownership at [www.horow.com](http://www.horow.com). Registration is voluntary and not required to maintain your limited warranty rights.



**For any questions or claims, please contact us by phone or email.**

**Phone: (+1)209-200-8033**

**Monday to Friday**

**Email: [support@horow.com](mailto:support@horow.com)**

When making a claim, please prepare a photo of the evidence of damage so that we can quickly resolve the claim for you.



### Warning

Content may contain sharp and other possibly harmful pieces and may cause hazard to children and adults, HOROW is not responsible in any way for personal damage.