

**HOROW®**

**Installation & User Manual**

# **HOROW** T38P

**Smart Toilet**

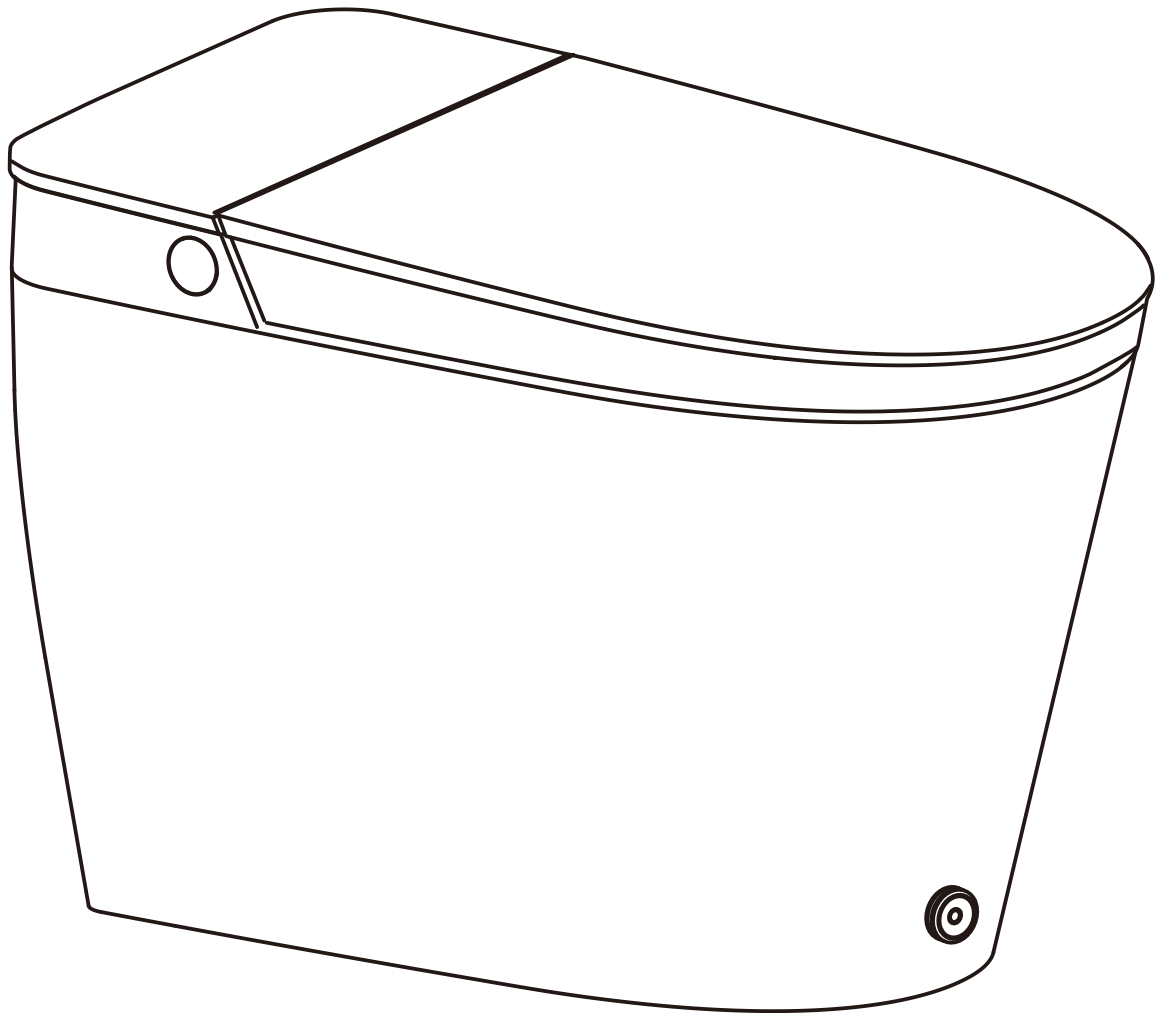

# Contents

<b>Important Safeguards</b> .....	<b>1</b>
Important Information .....	1
Grounding Instructions .....	2
Explanation of Terms and Symbols .....	2
<b>Overall Sketch</b> .....	<b>8</b>
<b>Function Table</b> .....	<b>9</b>
<b>Product Installation</b> .....	<b>10</b>
Tools Needed for Installation .....	10
Parts Included .....	10
Prior to Installation .....	11
Installation of Smart Toilet .....	12
Installation of Battery Pack .....	15
Installation of Remote Control Holder .....	16
Product Test Run .....	17
<b>Usage Instructions</b> .....	<b>18</b>
Function Explanations .....	18
Kick Control Operations .....	22
Side Button Operations .....	22
Remote Control Operations .....	23
<b>Daily Maintenance</b> .....	<b>27</b>
Maintenance of Ceramics, Seat and Lid .....	27
Maintenance of the Nozzle .....	28
Maintenance During Winter Season .....	28
<b>Troubleshooting</b> .....	<b>29</b>
<b>Specifications</b> .....	<b>31</b>
<b>Warranty</b> .....	<b>32</b>

- Thank You for Choosing HOROW. Please read the instructions carefully before installation and keep it available for future maintenance or reference.
- We are not responsible for the accidents resulting from the user's negligence.
- HOROW reserves the right to make revisions to this manual without notice.



**Need help? Contact HOROW Customer Service Team.**

**Phone: (+1)209-200-8033**

**Monday to Friday**

**Email: support@horow.com**

## Important Safeguards

**Read All Instructions Before Using**

### Important Information

When using electrical products, especially when children are present, basic safety precautions should always be followed, including the following:



**DANGER - To reduce the risk of electrocution:**

1. Do not use while bathing.
2. Do not place or store product where it can fall or be pulled into a tub or sink.
3. Do not place in or drop into water or other liquid.
4. Do not reach for a product that has fallen into water. Unplug it immediately.
5. Do not wash the main unit or electrical plug with water or detergent.
6. During installation, disassembly, repair and maintenance of the product, the power plug must be switched off and the water supply be shut off.



**WARNING - To reduce the risk of burns, electrocution, fire, or injury to persons:**

1. Close supervision is necessary when this product is used by, on, or near children or invalids.
2. Use this product only for its intended use as described in this manual. Do not use attachments not recommended by HOROW.
3. Never operate this product if the cord or plug is damaged, if it is not working properly, or if it has been dropped, damaged, or immersed in water. If any of these conditions apply, contact our Customer Service Team directly.
4. Keep the cord away from heated surfaces.
5. Never block the air openings of the product or place it on a soft surface, such as a bed or couch, where the openings could be blocked. Ensure that the air openings remain free of lint, hair, and similar debris.
6. Never use while sleeping or drowsy.
7. Never drop or insert any object into any opening or hose.
8. Do not use outdoors or in environments where aerosol (spray) products are being used or oxygen is being administered.
9. Connect this product to a properly grounded outlet only.  
See **Grounding Instructions**.
10. Caution - Risk of electric shock. Do not remove the toilet lid (or back) on your own. Refer servicing to qualified service personnel.

## Grounding Instructions

This product should be grounded. In the event of an electrical short circuit, grounding reduces the risk of electric shock by providing an escape wire for the electric current. The product is equipped with a cord that has a grounding wire and a grounding plug. The plug must be inserted into an outlet that is properly installed and grounded.



**DANGER - Improper use of the grounding plug can result in a risk of electric shock.**

1. If repair or replacement of the cord or plug is necessary, do not connect the grounding wire to either fat blade terminal. The wire within insulation having an outer surface that is green with or without yellow stripes is the grounding wire.
2. Check with a qualified electrician or serviceman if the grounding instructions are not completely understood, or if in doubt as to whether the product is properly grounded.
3. This product is factory equipped with a specific electric cord and plug to permit connection to a proper electric circuit. Make sure that the product is connected to an outlet having the same configuration as the plug.
4. No adapter should be used with this product. Do not modify the plug provided - if it will not fit the outlet, have the proper outlet installed by a qualified electrician. If the product must be reconnected for use on a different type of electric circuit, the reconnection should be made by qualified service personnel.

## Explanation of Terms and Symbols

To ensure proper and safe use of this product, please read this section carefully before use. After reading, store this manual in a safe place for any needed future reference.

The hazards and warnings listed herein are important to our user's safety. Significant consequences may result from failure to heed warnings. The company will not be held liable for any injuries or damages caused by improper use or failure to follow the safety instructions.

**Warning**

Indicate possible injury resulting from improper usage due to negligence of this sign.

**Attention**

Indicate human injury or property loss that may result from improper usage due to negligence of this sign.



Indicate a strict request to follow noted precautions when used with the above "Warning" and "Attention" signs.



Prohibit any individual from performing any action with this symbol.



Prohibit any individual from dismantling product.



Keep product away from any wet environments, including, but is not limited to, humid environments, close proximities to baths, showers or sinks.

 Do not touch!

 Operate only as instructed!

 Do not touch with a wet hand!

 Pull out the power plug!

 Keep away from any extreme heat or fire!

 Protective grounding.

## Warning

This product needs to be properly grounded.

- ※ Risk of electric shock.
- ※ If unsure, contact an electrician.



Do not place a lit cigarette along with other burning objects into the unit.

- ※ Risk of fire.



Do not touch, insert or pull out the power plug with a wet hand.

- ※ Risk of electric shock.



Do not use during thunderstorms (pull out the power plug during storms).

- ※ Failure in doing so may lead to injury or fault in the product.



Do not use a power socket in poor condition or a damaged power plug.

- ※ Risk of fire and/or electric shock.

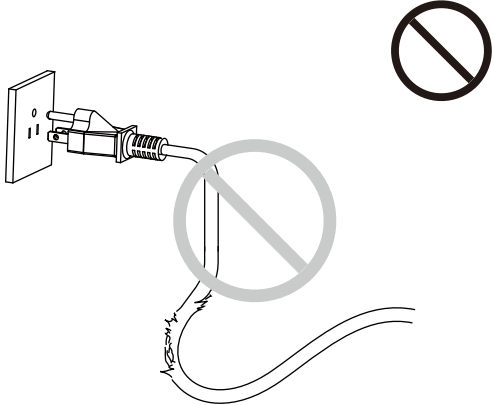

When the seat ring or the lid is damaged, to avoid any harm, be sure to pull off the power plug, close the water source and contact your local electrical installation company for replacement.

- ※ Risk of fire and/or electric shock.



The power socket in use should be within the specified range.

- ※ Risk of fire and/or electric shock.

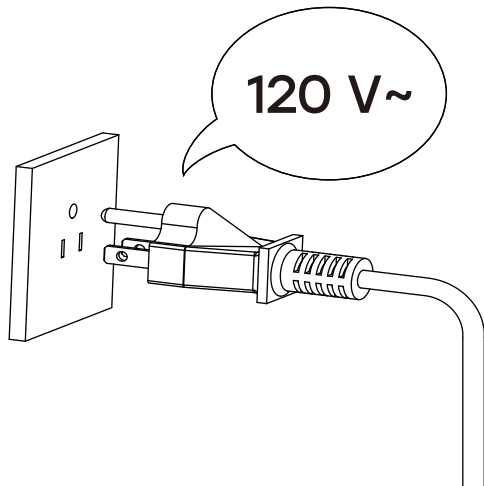

Regularly pull out the power plug and wipe off any dust on the power plug using a clean dry cloth.

- ※ Risk of fire.



Any person with a disability, the elderly, and children should be using this product with the supervision of another individual.

- ※ Be advised that sitting on the heated seat for an extended amount of time may result in burns.



Do not pull, damage, bend, twist, stretch, roll, bundle, clamp or squeeze the cord. Do not place anything on the cord.

- ※ Risk of fire and/or electric shock.



This product is not a toy. Advise children not to play with product.

- ※ Risk of injury.



If the power cord is damaged, to prevent any injuries or accidents, it should be replaced by a professional.

- ※ Risk of fire and/or electric shock.



Do not dismantle, repair or alter this product on your own. Call in a professional for further advice.

- ※ Risk of fire, electric shock, and/or other accident that may lead to injury.



For cleaning or maintenance of plastic parts, do not use any harsh cleaning agents. (These include, but are not limited to products such as concentrated sulfuric acid, concentrated nitric acid, glacial acetic acid, carbon tetrachloride, chloroform, benzene, phenol, methylphenol, dimethylformamide, methyl ether, soybean oil, acetate, 40% nitric acid, thick salt acid, 95% alcohol, gasoline, kerosene, etc.)



※ Risk of damaging parts that can lead to accidents and injuries.

Do not use polluted water or water meant for industrial use.



- ※ Risk of cystitis and dermatitis.
- ※ Untreated water may also cause internal corrosion of the product and may cause electrical shock or a fire.

Do not apply any force to the unit's seat and lid. Do not stand on the lid or open or close the lid and the seat forcefully.

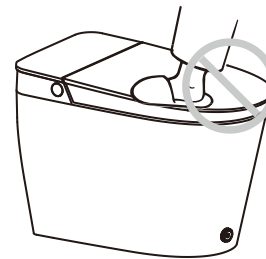

※ Risk of product damage and/or user injury.

Do not add water or detergent into the unit or onto the wireless remote control. Do not soak the product with water or cleaner.



※ Risk of fire and/or electric shock.

Do not install the product in a humid environment or a soaked room. Do not spray or soak this product with any form of liquid to prevent any damage to the product.



※ Risk of fire, electric shock, and/or other accident that may lead to user injury.

Do not place your hand or any other object into the dryer trap, and do not cover the dryer and dryer trap during product use.



※ Risk of fire, electric shock and/or other accident that may lead to user injury.

Do not spray urine at the dryer.



※ Risk of electric shock.

 **Battery Warning**

Read the following for proper battery usage.

- ① Properly install the battery according to its correct polarity.
- ② Remove the battery during long periods without use.
- ③ Replace the battery in time.
  - ✘ Failure to do so may result in interrupted control signals.
- ④ Cover the battery with tape before disposal. This will prevent battery fluid leaks that may cause fire and/or other damages.
- ⑤ Place the battery out of children and infant reach.
  - ✘ If battery is swallowed, contact a doctor immediately.
- ⑥ If battery fluid leaks onto user, quickly rinse off using clean water.
- ⑦ If battery fluid gets into eyes, do not rub your eyes. Quickly rinse it with clean water and consult a doctor immediately.
  - ✘ Failure to do so may result in vision impairment or blindness.

**When the battery is in use, do not do the following operations:**

- ① Do not hold or store with metal objects (such as a necklace or a watch).
- ② Do not mix new and old batteries.
- ③ Do not pull apart battery or throw it into water and/or fire. Battery fluids may cause a fire.



 **Attention**

Do not use the heated seat or warm dryer temperature for an extended amount of time.

- ※ Extended use may result in burns.



Avoid direct sunlight or heat.

- ※ Risk of product discoloration.



While using this product, make sure that the skin is in contact with the seat sensor area. Otherwise, the product may not operate correctly.

- ※ Children and smaller individuals may have trouble staying in contact with sensor area.



Do not spray urine in the direction of the bidet nozzle.

- ※ Doing so may result in blockage to the bidet nozzles and cleaning area.



Do not supply electricity with an external switch, i.e., connecting the universal part to a timer switch.

- ※ Risk of problems caused by improperly resetting the thermal breaker.



Pull out the power plug when the product is in disuse for an extended amount of time. Make sure to shut off the water and remove the water inside the product.

- ※ Risk of fire, leakage and product damage.



When storing or transporting in cold climate, make sure to remove all water from the unit. Product may crack and other damages may occur due to freezing water.

- ※ Risk of fire, leakage and product damage.



In case of sudden power failure, pull out the power plug and turn off the angle valve to prevent water leakage.

- ※ Risk of water leakage and/or property loss.



# Overall Sketch

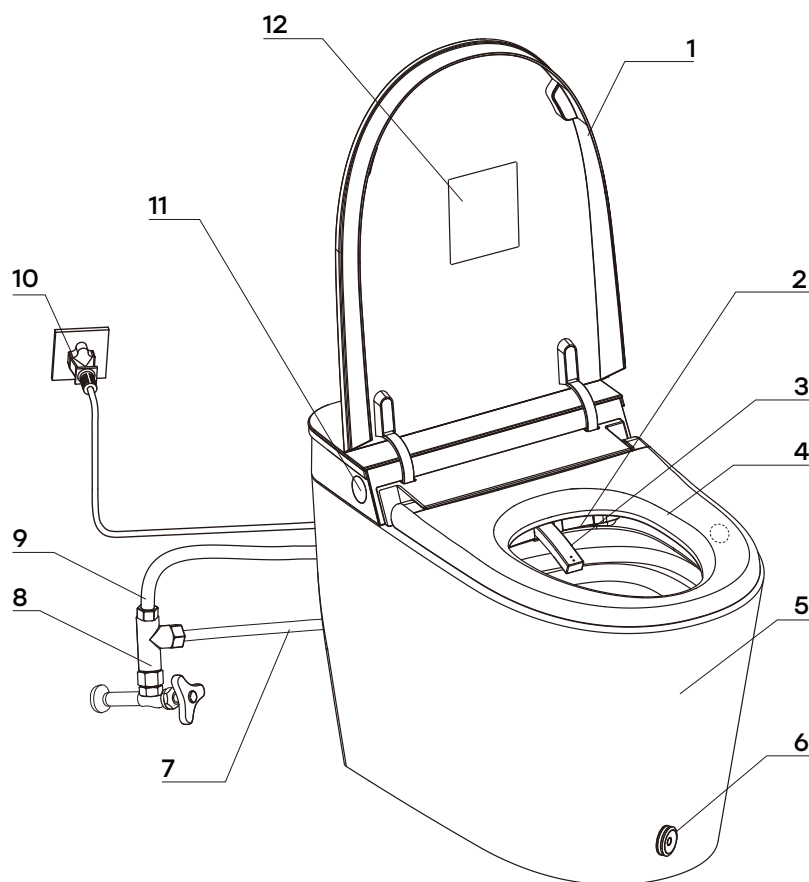

1	Lid
2	Warm Dryer
3	Detachable Nozzle
4	Heated Seat
5	Ceramic Toilet Bowl
6	Kick Control
7	Flush Water Hose </td
8	T-valve
9	Clean Water Hose
10	Power Plug
11	Side Button
12	Caution

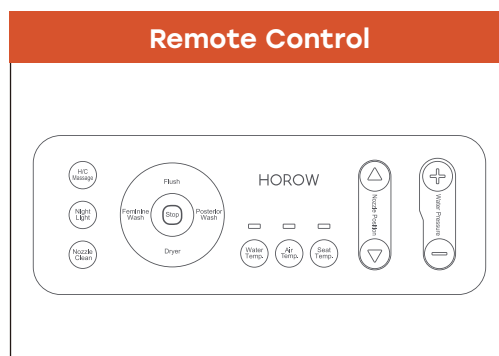
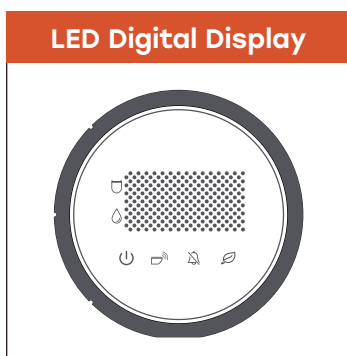

※ Two AAA batteries for the remote control are included in the product package.

# Function Table

Category	Model	
	Functions	T38P
Hygiene	Feminine Wash	●
	Posterior Wash	●
	Movement Wash	●
	H/C Massage	●
	Self-cleaning Nozzle	●
	Detachable Nozzle	●
	Nozzle Clean	●
	UV Sterilization	●
	Anti-bacterial Seat	●
	Easy-clean Glaze	●
	Pre-wet	●
Comfort	Instant Heating	●
	Adjustable Water Temperature	●
	Adjustable Water Pressure	●
	Bubble Wash (Water & Air Mixed)	●
	Adjustable Nozzle Position	●
	Heated Seat	●
	Adjustable Seat Temperature	●
	Warm Dryer	●
	Adjustable Dryer Temperature	●
	Foam Shield	●
	Auto Deodorization	●
	ADA Height	●
Convenience	Auto Open Lid	●
	Auto Wash	●
	Auto Flush	●
	Drying Flush	●
	Blackout Flush	●
	Remote Flush	●
	LED Digital Display	●
	Remote Open Lid/Seat	●
	Kick Open Lid/Seat	●
	Night Light	●
	Energy-saving Mode	●
	Soft Close	●
	Factory Data Reset	●
Safety	SUS Filter	●
	Air Isolation & Backflow Prevention	●
	Multiple Protections	●
	Fire and Heat Resistant	●

Note: The blackout flush battery pack for power outage is not included and must be purchased separately. If you want to purchase the battery pack, please contact our Customer Service Team.

# Product Installation





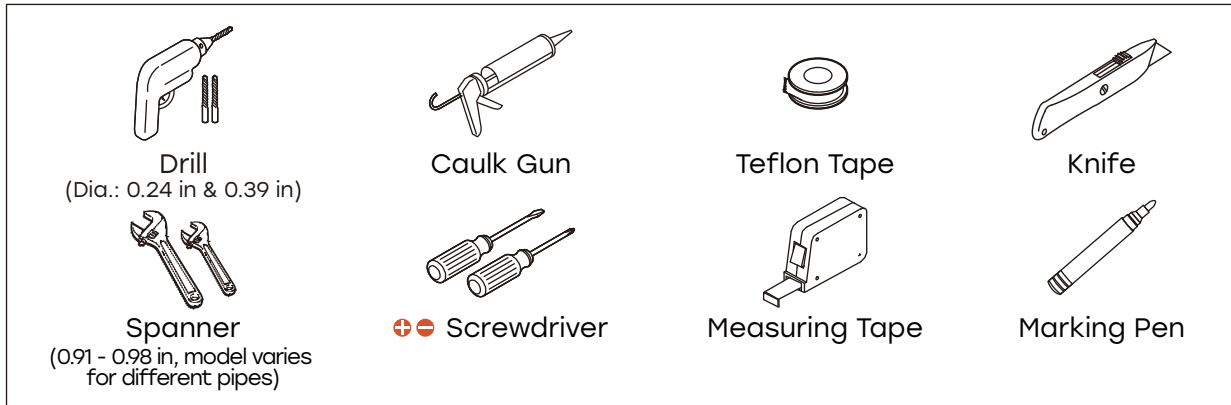





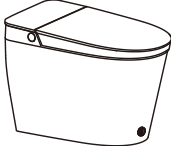
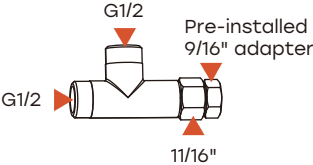
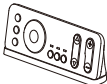
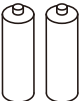

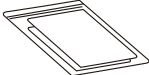
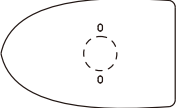
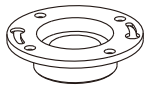

















## Tools Needed for Installation

Please have these tools prepared prior to installation.



## Parts Included

Please confirm that all items below are inside the box.

<p>Smart Toilet (1 pc)</p> 	<p>T-valve (1 pc)</p> 	<p>Remote Control Set (1 pc)</p>  <p>(holder 1 pc, screw 2 pcs)</p>									
<p>Two AAA Batteries</p> 	<p>Wax Ring (1 pc)</p> 	<p>Installation &amp; User Manual</p> 									
<p>Installation Template (1 pc)</p> 	<p>Floor Flange (1 pc)</p> 	<p>Funnel (1 pc)</p> 									
<p>Mounting Accessory Kit:</p> <table border="0"> <tr> <td> Expansion Bolt (4 pcs)</td> <td> Mounting Block (2 pcs)</td> <td> Fixing Sleeve (2 pcs)</td> </tr> <tr> <td> Screw (4 pcs)</td> <td> Toilet Screw (2 pcs)</td> <td> Bolt (2 pcs)</td> </tr> <tr> <td> Washer (6 pcs)</td> <td> Nut (2 pcs)</td> <td> Decorative Cap (2 pcs)</td> </tr> </table>			 Expansion Bolt (4 pcs)	 Mounting Block (2 pcs)	 Fixing Sleeve (2 pcs)	 Screw (4 pcs)	 Toilet Screw (2 pcs)	 Bolt (2 pcs)	 Washer (6 pcs)	 Nut (2 pcs)	 Decorative Cap (2 pcs)
 Expansion Bolt (4 pcs)	 Mounting Block (2 pcs)	 Fixing Sleeve (2 pcs)									
 Screw (4 pcs)	 Toilet Screw (2 pcs)	 Bolt (2 pcs)									
 Washer (6 pcs)	 Nut (2 pcs)	 Decorative Cap (2 pcs)									

## Prior to Installation

Please confirm that all the aforementioned items in the package are present. In case of any missing parts, please feel free to contact our Customer Service Team. Illustrations above are for reference only. The ceramic product may have slight deformation during the firing process. Please consult the actual product for accurate details.

Verify the product dimensions and secure enough installation space. The rough-in size refers to the distance between the center of the toilet flange to the finished back wall.

※ All dimensions are manually measured with a certain degree of error. For the specific size, please refer to the actual product received.

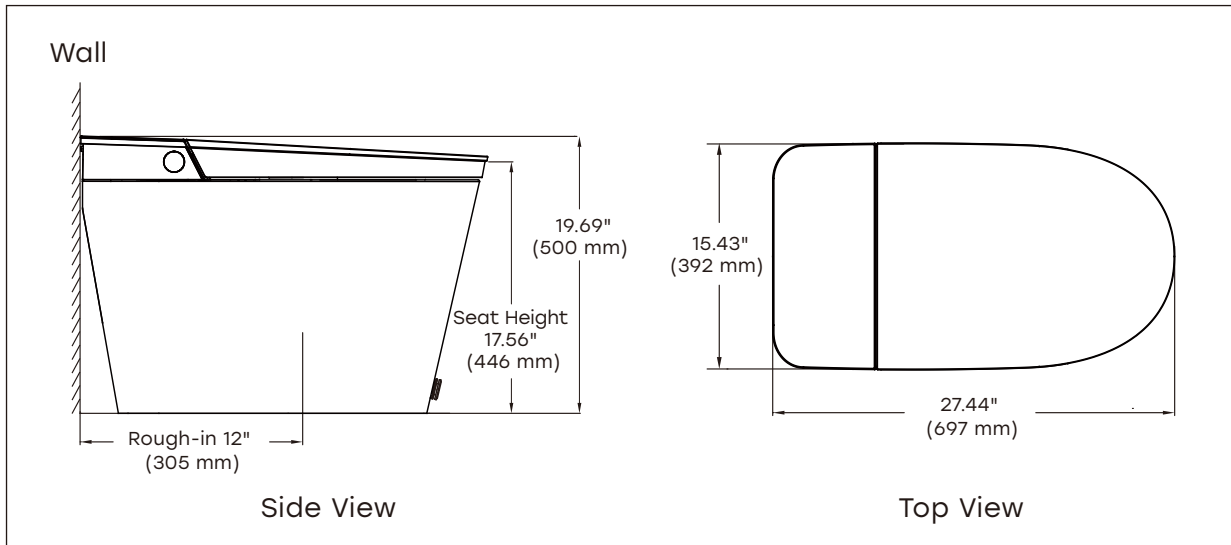

To ensure proper installation, the distance between the water supply valve and the centerline of the toilet should be greater than half the width of the toilet bottom. The water supply valve should be about 8 inches away from the toilet centerline. For larger valves, a greater distance may be necessary to ensure proper clearance. For easy installation and maintenance, a range of 9 to 11 inches is recommended.

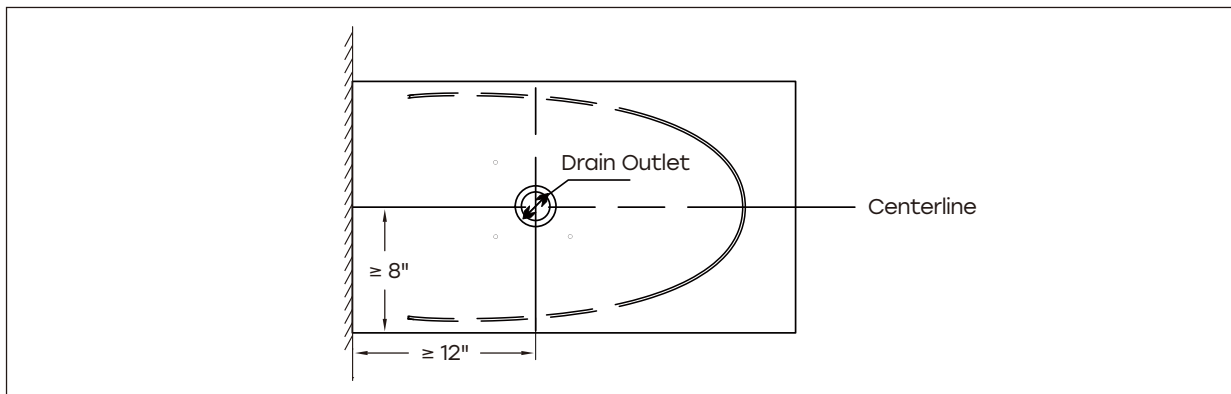

The minimum water pressure required is 11.6 psi, and the maximum water pressure is 108 psi. If the minimum water pressure is not met, the smart toilet may not achieve the optimal cleaning performance. However, since the product includes a built-in water tank and pump, its ceramic scouring effect is not affected by external water flow, pressure, or other environmental factors.

Electrical requirements for this product: 16 Amps at AC 120 V, 60 Hz.

## Installation of Smart Toilet

Install your toilet using the following steps:

Please remove the old toilet first if any and ensure the mounting surface is clean and level before the new toilet is installed.

### 1 Open the box right side up

Remove the accessories first, then lift the toilet with two people, remove the packaging, and gently place the toilet on the floor, as shown in the diagrams below.

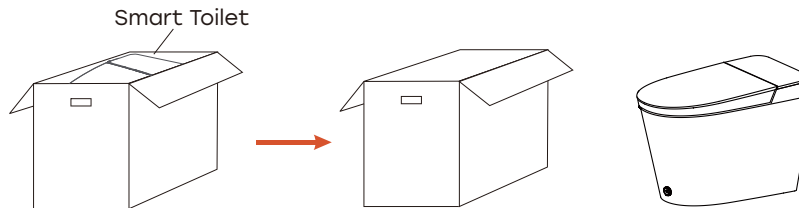

### 2 Install with installation template

Align the installation template with the centerline of drain outlet.

Mark four mounting holes based on the installation template with the marking pen. Then, outline the edges of the template to mark the toilet placement for later installation.

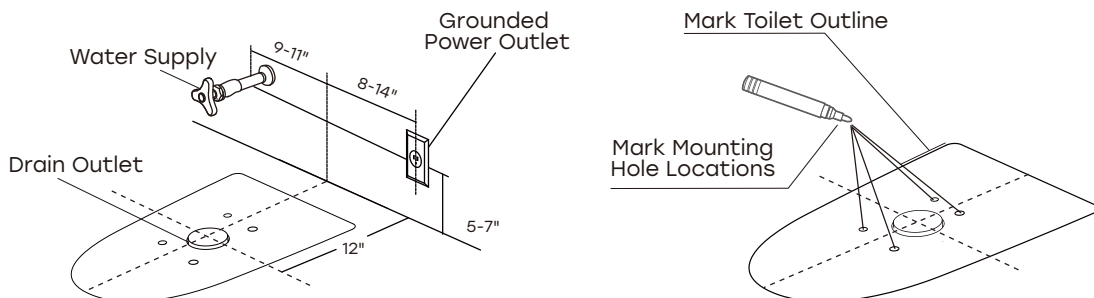

### 3 Install and fix the flange

Drill four 0.39-in (10 mm) holes at the marked locations from the previous step. Insert four expansion bolts into the holes. Position the flange on the drain pipe outlet, aligning the four flange holes with the drilled holes on the ground. Then, insert the washers and screws into the flange holes and tighten them using a screwdriver.

※ If an applicable flange is already in place, there is no need to install the new one.

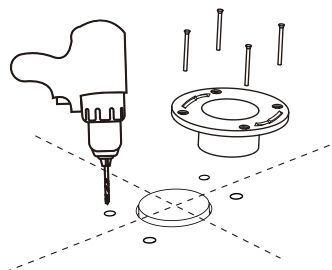

**4 Install the mounting blocks**

Assemble the mounting blocks with bolts, position the two mounting blocks on opposite sides of the flange on the ground and secure them with washers and nuts.

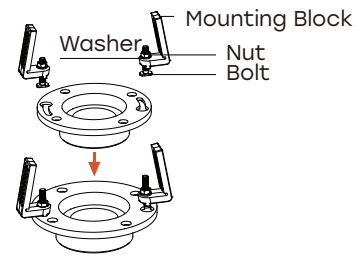
**5 Install the ceramic toilet**

Install the wax ring onto the drain hole at the bottom of the ceramic toilet and press it firmly into place.

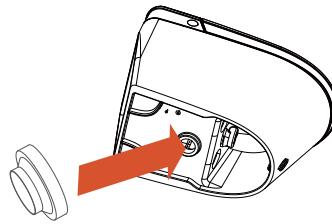

Lift the ceramic toilet with two people and gently lower it onto the flange, letting it well fit the mounting blocks.

Press down firmly on the ceramic toilet to ensure the wax ring forms a complete seal.

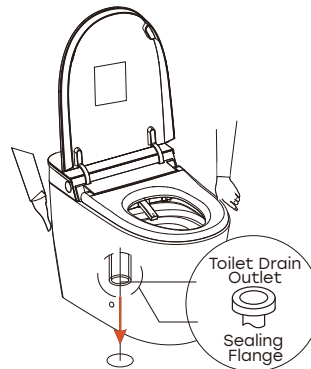

Insert the screw through the fixing sleeve, then through the holes on both sides of the ceramic toilet and into the mounting blocks on the ground. Tighten them securely using a screwdriver.

Put the decorative cap onto the fixing sleeve.

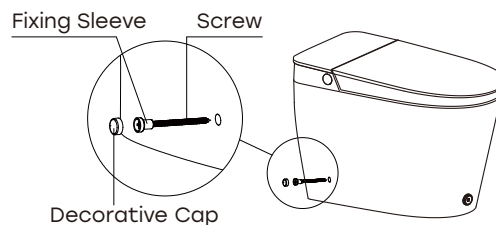

Tips:

- ✘ The toilet is heavy, and it needs two people to carry it.
- ✘ Please clean the drain outlet.
- ✘ Please make sure ceramic toilet outlet sits perfectly on the drain outlet.

**6 Install the T-valve and water hoses**

Connect the T-valve to the water supply (Available in 9/16" adapter).  
Use Teflon tape on all threaded connections to ensure a water tight seal.  
Use gasket to prevent water leakage.

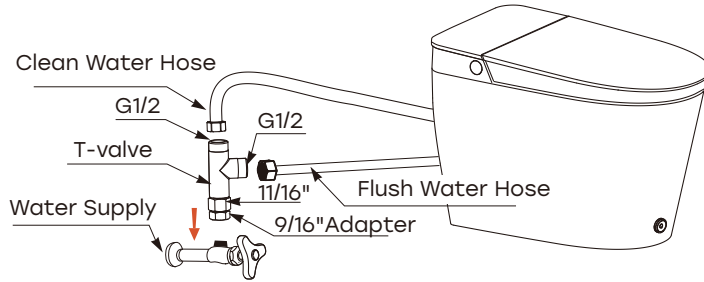

**Note:**  
If your water valve is 9/16", you could directly connect the T-valve; If your water valve is 11/16", please screw off the adapter, then connect it.

Connect the smaller wire-braided flush water hose to the T-valve and tighten it.

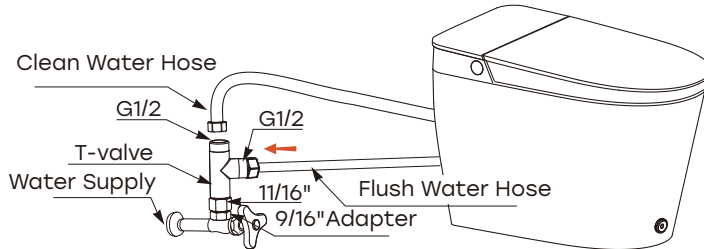

Connect the larger nylon-braided clean water hose to the T-valve and tighten it.

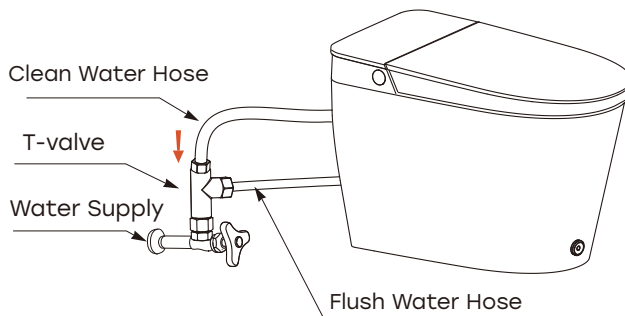

## Installation of Battery Pack

The battery pack is primarily used for blackout flush in case of a power outage. It provides emergency power to the toilet and needs to be purchased separately. For any questions, please contact Customer Service Team.

### + Install the external battery pack

Locate and hold the connecting cable at the position where indicated.

Remove the protective cap from the connecting cable.

Insert the waterproof DC power plug of the battery pack into the connecting cable and tighten the waterproof cap securely.

Place the battery pack in an appropriate location as shown below.

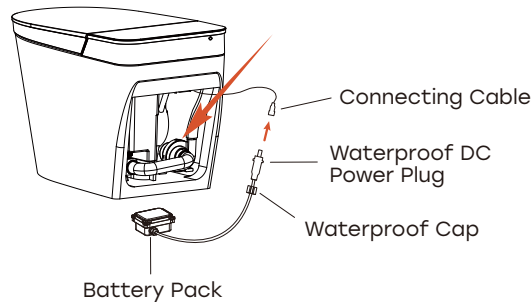

- ※ The battery should be placed out of the reach of children.
- ※ Some batteries and connecting cables may have slots. Please do not forcibly insert, otherwise, it will lead to product damage.

### + Replace the external battery pack

Unscrew the waterproof cap at the connection of the waterproof DC power plug.

Pull out the waterproof DC power plug.

Replace the battery pack with a new one, which can be used after installation.



- ※ The battery pack for blackout flush has an IPX6 waterproof rating. A single battery pack can support approximately 200 flushes during a power outage. Please note that the battery naturally degrades over time, even when not in use.

## Installation of Remote Control Holder



Drill two 0.24-in (6 mm) holes in the wall (about 1.77 inches deep).

Knock the anchors into the hole with a hammer.

Secure the holder with anchors.

Use the screws to secure the holder to the wall.

Remove the battery cover from the backside of the remote control to install batteries.

Once finished, the remote control is ready to be placed in its holder.

Detailed steps are shown in the diagrams below:

- ※ Please use proper mounting tools for special wall surfaces (such as wood, HDF, etc.)
- ※ The remote control holder should be installed away from the bidet's spray trajectory.
- ※ The remote control holder should be installed within reach when seated on the toilet.
- ※ Make sure there is nothing to block the transmission between the toilet and its remote control.

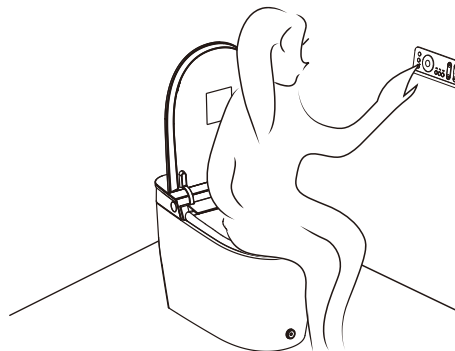

### Steps:

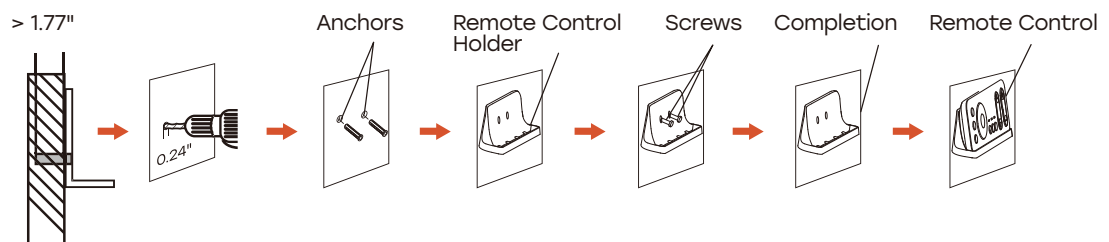

## Product Test Run

### 1 Water Connection

Turn the water supply angle valve to the maximum opening, as shown in the diagram.

Make sure no leakage is found at various connection parts.

※ In case of any water leakage, unfasten the nuts and install them again.

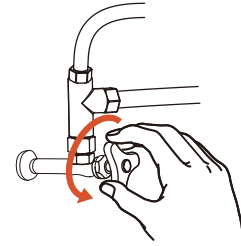

### 2 Power Connection

Ensure the electrical requirements are met: 16 A at AC 120 V, 60 Hz.

Plug the power plug into AC 120 V socket.

Press the side button on the toilet to start a flush and confirm the toilet is powered on.

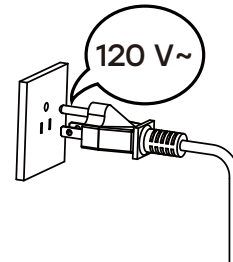

### 3 Smart Toilet Running

Are all functions working properly?

Test all function buttons on the remote control and the side button on the toilet.

Verify the normal operation of each function.

Operate the remote control and confirm the functionality of Posterior Wash, Feminine Wash (including water pressure and nozzle position adjustment), Warm Dryer, Air Temperature and Water Temperature Adjustment, Nozzle Clean and Night Light.

All functions listed above should be tested. Please ensure all specified functions run correctly.

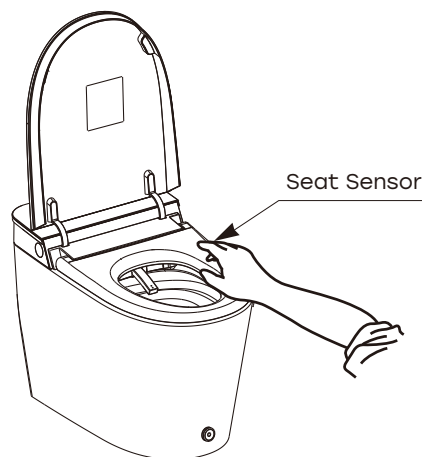

After the toilet is installed and the test run is completed, it is recommended that you apply the silicone sealant around the base of the toilet. Please avoid applying sealant where the access covers meet the floor.

# Usage Instructions

## Function Explanations



### Auto Flush

The toilet will automatically flush after the seat sensor no longer detects a user if no flush is performed during seat occupancy. If the seat is occupied for less than 2 minutes, a half flush will be triggered automatically. If the seat is occupied for over 2 minutes, a full flush will be executed.

Additionally, the toilet will automatically flush after the lid is closed, if a male user urinates while the seat is unoccupied.

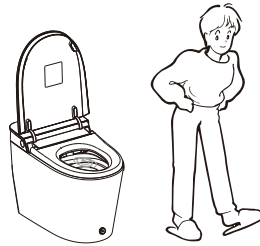

### Drying Flush

Press **Dryer** on the remote control to activate the dryer to blow warm air.

If no flush is executed after posterior or feminine wash, a flush will be performed automatically to eliminate unpleasant odors before the dryer is activated.

Posterior/feminine wash is not available during the flush process.

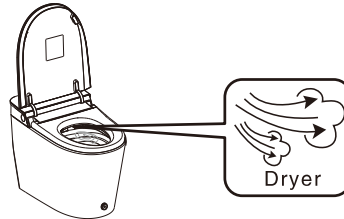

### Blackout Flush

Blackout flush refers to the manual emergency flush during a power outage.

Press the side button  or lightly tap the **Kick Control** to activate blackout flush.

If the above operations do not work properly, you need to replace the battery pack or contact our Customer Service Team.

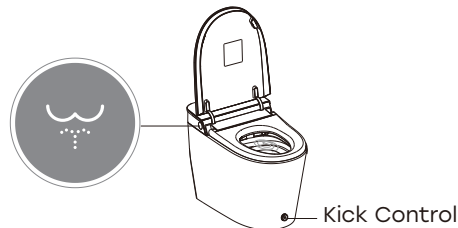

**+ Microwave Induction**

Microwave induction, also known as auto open/close lid, uses the microwave induction technology to detect users within a default radius of 15.75 inches.

The lid will automatically open when a user approaches within this range.

The lid will automatically close when the user leaves for a while and the sensor no longer detects any microwave signal.

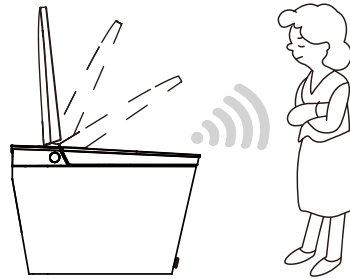
**+ LED Digital Display**

When different functions are activated, the corresponding function animation is displayed or the indicator light is on.

The  icon indicates the seat temperature.

The  icon indicates the cleaning water temperature.

The  icon indicates that the power indicator light is on.

The  icon indicates that the microwave induction function is activated.

The  icon indicates that the Do Not Disturb function is activated.

The  icon indicates the auto deodorization function is activated.

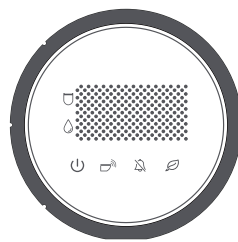



**Foam Shield**

A foam dispenser is embedded in the back of the toilet, using a dedicated foam cleaner to create a foam shield. The dense foam shield covers the water surface, effectively preventing splashing, isolating unpleasant odors and reducing airborne bacteria. Additionally, the foam lubricates the toilet wall, preventing waste from sticking and making cleaning more convenient.

Press **Posterior Wash** to generate a foam shield immediately when the seat is unoccupied. Or enable the auto foam shield function to let the toilet automatically create a foam shield when the seat is occupied.

**Foam Cleaner Filling**

The toilet needs to add foam cleaner for the first use. The foam cleaner is not included in the product package and must be purchased separately. If you want to purchase it, please contact our Customer Service Team. Additionally, the auto foam shield function is disabled by default. To enable it, please refer to the instructions in **Settings Mode**.

※ Before filling the foam cleaner, please unplug the toilet. Once the foam cleaner is added, reconnect the toilet to the power supply.

1. Push the decorative panel to the left to remove it, then take out the silicone stopper from the filling port.
2. Use the provided funnel to pour the foaming cleaner into the dispenser through the filling port.
3. Put the silicone stopper back into the filling port. Then push the decorative panel to the right to secure it in place.
4. If no foam is released when pressing **Posterior Wash** while unseated, or when the seat is occupied with the auto foam shield function enabled, it indicates that the foam cleaner is empty and needs to be refilled. Please follow the steps above to refill it.

※ Please use customized foam cleaner. Otherwise, it may cause clogging and damage to internal components.

※ When filling the foam cleaner or performing maintenance, be careful not to let sediment and other impurities fall into the filling port.

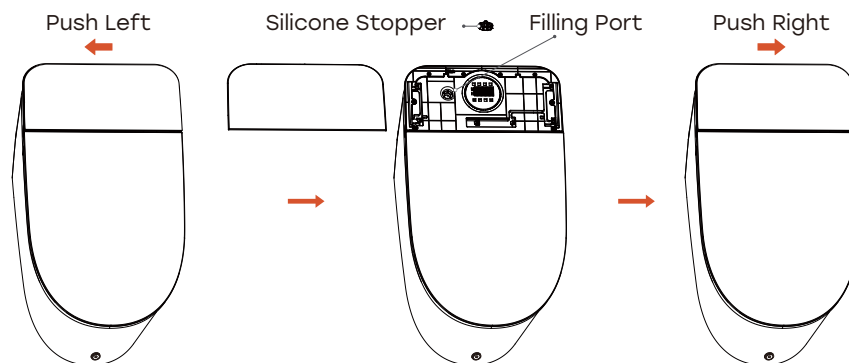

**Auto Deodorization**

The deodorization function will be activated automatically when the seat is occupied and will be turned off once the seat is unoccupied.

A deodorizer cartridge and a fan are installed at the back of the toilet to help eliminate unpleasant odors and improve ventilation.

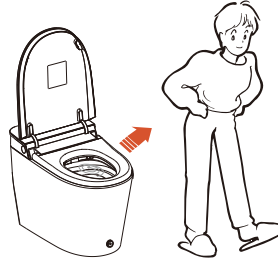
**UV Sterilization**

An ultraviolet lamp is installed and concealed inside the smart toilet.

Ultraviolet rays sterilize the nozzle surface. UV sterilization will start automatically 10 seconds after the seat is unoccupied and it will work for 3 minutes.

Pressing **Stop** or activating the seat sensor will stop the UV sterilization process.

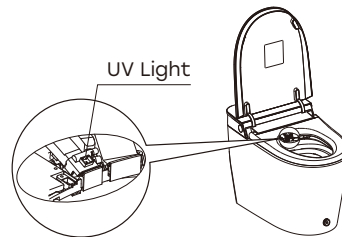
**User-friendly Design****① Pre-wet**

When the toilet seat is occupied, the product will flush automatically once towards the seat to moisten the toilet bowl.

**② Multiple Protections**

Multiple built-in safety features are designed to protect both the user and the product.

**③ Memory Mode**

The toilet automatically remembers and retains the last-used settings, including water temperature, seat temperature, warm air temperature, nozzle position and other user preferences. Such settings will revert to factory defaults in the event of a power failure.

**④ Antibacterial Seat**

The seat is made of antibacterial material to ensure enhanced hygiene.

**⑤ Energy-saving Mode**

When enabled, the toilet conserves energy by maintaining the heated seat temperature at 86 °F when not in use.

## Kick Control Operations

+

The toilet is equipped with a kick control in front of the toilet to control the open and close of the lid and the seat as well as the kick flush when the lid is closed.

Tap the **Kick Control** with your foot to raise your toilet lid/seat.

Tap the kick button once: Lid opens.

Tap the kick button twice: Seat raises.

Tap the kick button three times: Seat and lid will close and the toilet will flush immediately.

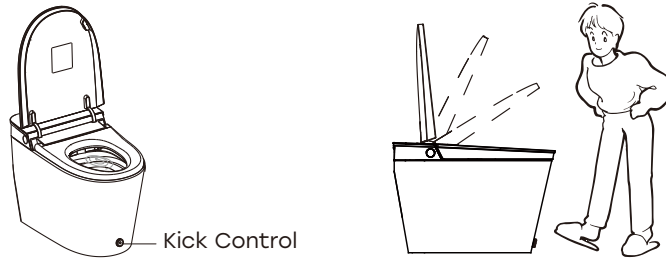

If the Kick Control is kicked when the seat is occupied, a wash cycle will start automatically. The entire process includes posterior wash, auto flush and warm air drying.

※ It is a dual flush toilet. The kick control triggers only a half flush, while the side button or the remote control activates a full flush. In addition, if the seat is occupied over 2 minutes, the auto flush triggered is also a full flush.

## Side Button Operations

+

### Power/Stop

When the toilet is powered on and no one is seated, press and hold the side button for 3 seconds to enter the standby mode.

When the toilet is in standby mode, press and hold the side button for 3 seconds to activate it.

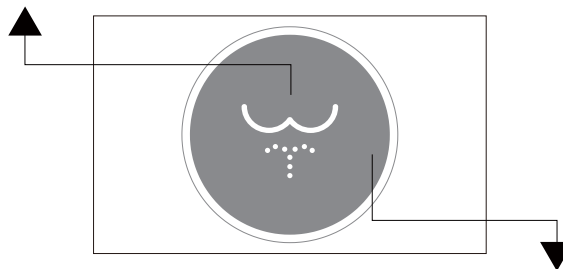

### Posterior

When the toilet is in posterior wash or drying mode, press the side button to stop the function.

When the toilet is in wash mode, press and hold the side button for 3 seconds to turn on the dryer.

When the seat is occupied and the toilet is not in wash or drying mode, press the side button to start the wash cycle. Movement wash is provided by default.

The entire process includes posterior wash, auto flush and warm air drying, taking approximately 5.5 minutes.

When the seat is unoccupied and the toilet is not in use, press the side button to immediately flush the toilet.

## Remote Control Operations

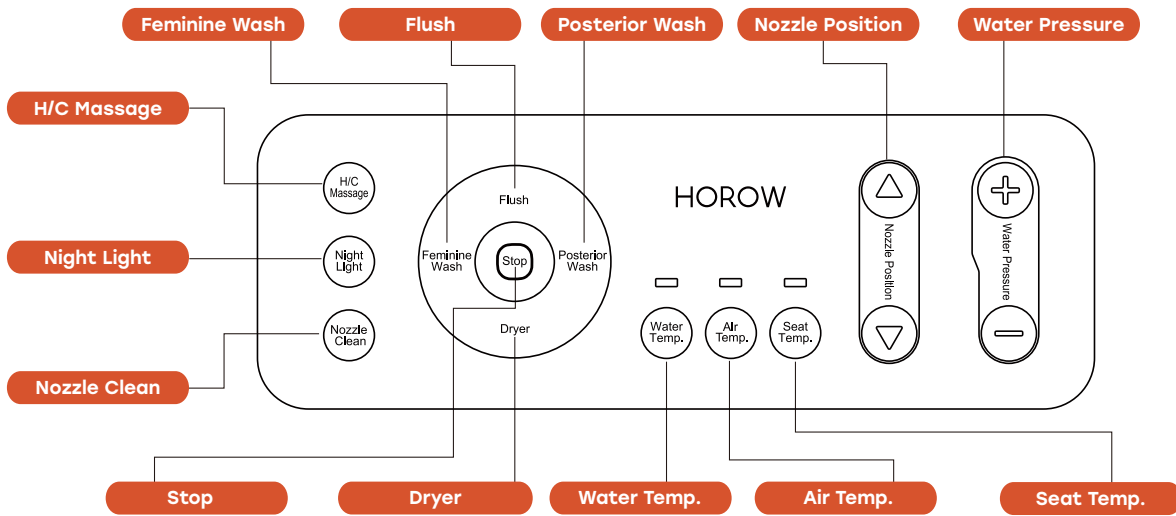

Press **Flush** to flush the toilet after use.

Press **Posterior Wash** to start posterior cleaning while seated. Movement wash is provided by default. Press again to stop movement wash and return to posterior wash. It will stop after approximately 4 minutes.

Press **Posterior Wash** to start to generate a foam shield immediately while unseated.

Press **Feminine Wash** to start feminine cleaning while seated. Movement wash is provided by default. Press again to stop movement wash and return to feminine wash. It will stop after approximately 4 minutes.

Press **Dryer** to dry off the water after using the wash function. It will stop after approximately 4 minutes.

Press **Stop** to stop any activated wash functions (posterior wash or feminine wash) or the dryer.

Press **H/C Massage** to switch between warm and cold water washing during any wash process. Press **H/C Massage** to remotely control auto open/close of the lid and seat while unseated.

Press **Night Light** to turn the night light on or off.

Press **Nozzle Clean** to extend the nozzle out while unseated, allowing the user to easily detach and clean it manually.

Press **Water Temp.** to adjust the water temperature for any wash function.

Press **Air Temp.** to adjust the warm air temperature of the dryer during drying.

Press **Seat Temp.** to adjust the heated seat temperature while seated.

Press **Nozzle Position** to adjust the nozzle position.

Press **Water Pressure** to adjust the cleaning intensity of feminine wash and posterior wash.

## Remote Control Settings for Special Modes

### • Energy-saving Mode

When enabled, the toilet conserves energy by maintaining the heated seat temperature at 86 °F when not in use. Once seated, the seat returns to the preset temperature (Except for High Level, which will be heated to 98.6 °F).

Press and hold **Night Light** for 3 seconds to enable the energy-saving mode.

### • Settings Mode

If entering this mode, the remote control can be used to enable or disable the automatic functions of the toilet as described below.

Press and hold **H/C Massage** and **Flush** simultaneously for 3 seconds until a long beep is heard to enter the Settings Mode.

Note: The automatic functions are enabled by default from the factory, except for the Do Not Disturb function and the auto foam shield function. To make adjustments, please enter into the Settings Mode to enable or disable these functions.

A short beep indicates that the function has been enabled, while 2 short beeps indicate that the function has been disabled.

Press **Nozzle Position**  $\triangle$  to enable/disable the pre-wet function.

Press **Nozzle Position**  $\nabla$  to enable/disable the auto flush function.

Press **Seat Temp.** to enable/disable the Do Not Disturb function. The function is disabled by default. When enabled, no audio prompts will be heard during side button and remote control operations.

Press **Water Temp.** to enable/disable the auto foam shield function. When enabled, the toilet will automatically create a foam shield over water surface in the bowl whenever the seat sensor detects a user.

Press **Nozzle Clean** to enable/disable the LED digital display. When enabled, both the LED digital display and the ambient light are turned on. When disabled, both the LED digital display and the ambient light are turned off.

Press **Night Light** to enable/disable the foot kick light function.

Press **H/C Massage** to enable/disable the microwave induction function (auto open/close lid).

Press **Air Temp.** to enable/disable the auto deodorization function.

Press **Water Pressure**  $\oplus$  to set the corresponding color of the ambient light. There are five color modes in total, and each press will switch to the next color in the following sequence: cyan, blue, orange, white, and then an automatic cycle through all four colors.

After the settings needed are completed, press and hold **H/C Massage** and **Flush** for 3 seconds until 3 short beeps are heard to save the settings and exit the Settings Mode.

If no operation is done within 1 minute after entering Settings Mode, the mode will automatically exit with 3 short beeps. When entering Settings Mode, the side button light will turn off; when exiting, the side button light will return to a steady on state.

### • Engineering Settings Mode

Engineer Settings Mode is used for level adjustment of microwave induction (auto open/close lid).

Pull out the power plug to cut off the power supply. Next, press and hold the side button and then plug the power plug at the same time. Release the side button when the first long beep is heard. Within 6 seconds, press and hold the side button again, and release it when the second long beep is heard to enter the Engineering Settings Mode.

Press **H/C Massage** on the remote control to enter the level adjustment of microwave induction function.

※ If the power indicator light of the toilet is on or the toilet lid opens automatically, it indicates a failure to enter Engineering Settings Mode. Please repeat the steps described above.

Press **Nozzle Position**  $\triangle$  / **Nozzle Position**  $\nabla$  to adjust the microwave induction levels.

Press **Nozzle Position**  $\triangle$  to add one level. Press **Nozzle Position**  $\nabla$  to reduce one level.

Two high-pitched beeps indicate an invalid adjustment, meaning the microwave induction is already at the highest or lowest level.

Press and hold the side button for 3 seconds to save the settings and power on. The product restarts and enters into normal working. If the remote control is not operated for more than 1 minute and the product automatically enters the power on state, the logic before setting is retained. If power failure or other misoperation occurs midway, the logic before setting is retained.

<b>Level Position</b>	<b>Distance for Lid Auto Open (in)</b>	<b>Distance for Lid Auto Close (in)</b>
1 <sup>st</sup> Level	7.87	23.62
2 <sup>nd</sup> Level	15.75	35.43
3 <sup>rd</sup> Level	23.62	47.24

**Note:**

The microwave induction distance for the auto open/close lid described above refers to the distance between the user and the front edge of the toilet seat.

## Code Pairing of Remote Control

The remote control is pre-paired with the smart toilet at the factory for immediate use. However, if the remote control isn't functioning properly, or if you own multiple toilets of the same brand and experience interference when operating them, you can manually pair the remote control with the toilet.



Unplug the toilet. Press and hold **Stop** for a few seconds until three level lights flicker.

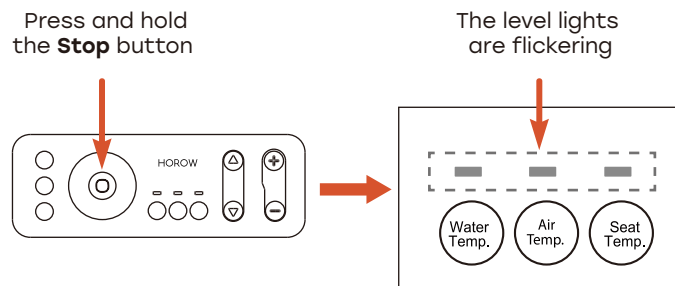

Place the remote control near the product and plug the attaching plug.

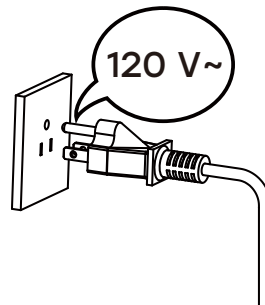

The level lights stop flickering, and then they are lighted on. Codes are paired successfully when all lights are on.

All the level lights are normally on

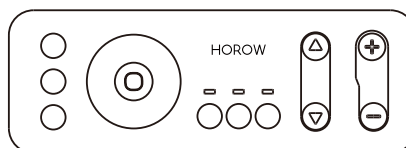

## Daily Maintenance

Regular maintenance is required to ensure normal use.

**+****Note:**

1. Cut off the power and water supply before maintenance.
2. Direct water wash to the entire product is prohibited.

**+****Warning:**

Do not spray water or detergents on the toilet, remote control or the power cord. Doing so may cause electric shock or fire.

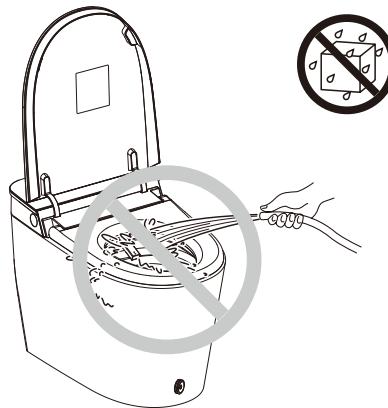

## Maintenance of Ceramics, Seat and Lid

**+**

1. Wipe dust or stains with a soft wet cloth.
2. A wet soft brush, cloth, or sponge may be used to clean the ceramic area.



※ Do not use abrasive cleaners, such as alcohol, bleach, painter thinner, cresol, benzene, gasoline, etc.

## Maintenance of the Nozzle



Press **Nozzle Clean** button on the remote control without occupying the seat when the toilet is powered on. The nozzle will extend out. Proceed to clean it with a soft toothbrush. The nozzle can be disassembled to clean.

Press **Nozzle Clean** button again, and the nozzle will return to the original position.

- ※ Do not forcefully hold the nozzle, otherwise it may break.
- ※ Please replace the spout with a new one if it is clogged.

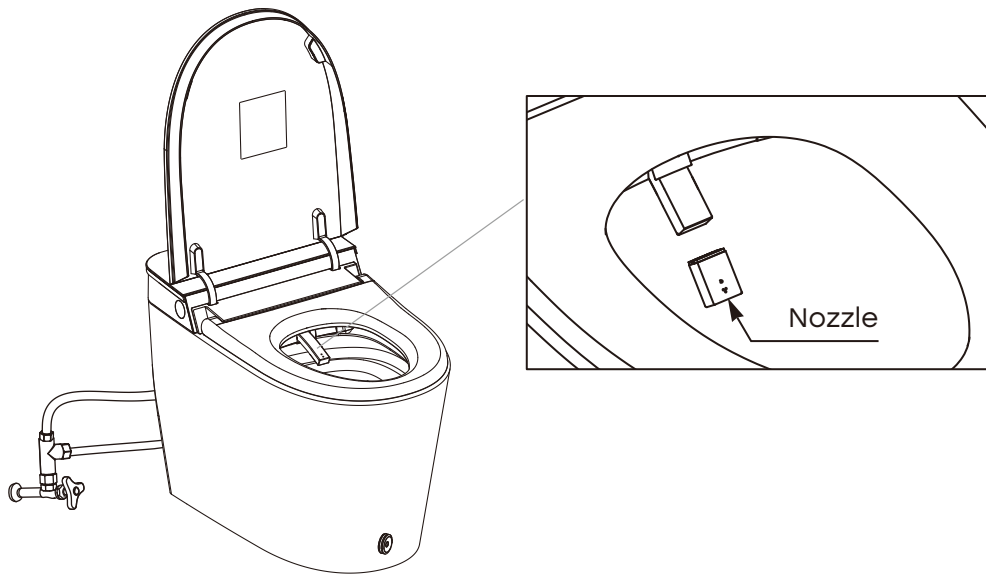

## Maintenance During Winter Season

During the winter season, the water inside may freeze after long periods of storage and non-use. Please take measures to prevent.



**Note:**

1. Before connecting the product to the water supply and electrical outlet, allow it to defrost for 30 minutes in a warm indoor environment.
2. In cases of extreme cold/freezing/nozzle stuck in place, wrap the water input line with a warm towel. Never pour hot water or use a hot dryer directly on the toilet.

# Troubleshooting

This Troubleshooting Guide is for general aid only. If the user encounters any problems, please first consult the troubleshooting guide below. If the problem persists, please contact our Customer Service Team.



Scan the QR code for video resources and find the troubleshooting videos you need.

Power Button		
Phenomenon	Fault Diagnoses	Solutions
Not working	Check whether the attaching plug is loose or not	Please check the circuit
	Check whether the power is switching on or off (the power light is not on)	Press and hold the side button  , the power light is on
	Check whether there is any electric leakage or not	Unplug the attaching plug from the socket, plug it again later, if it is still not working, please unplug the attaching plug and contact our Customer Service Team
Wash Functions		
Phenomenon	Fault Diagnoses	Solutions
No water from the spout	Check whether the water supply cuts off or not	Wait for the water supply restoring
	Check whether the angle valve switches off or not	Open the angle valve
	Check whether the water filter is blocked or not	Clean the filter mesh or change the water filter
	Check whether the inlet pipe is flexed or not	The inlet pipe must be straight
The intensity of cleaning is not strong enough	Check whether the water pressure of cleaning switches to low level or not	Regulate the water pressure according to the Installation & User Manual
	Check whether the inlet filter is blocked or not	Clean the filter mesh or change the water filter
Unusual water flow from the spout	Abnormal operation	Unplug the attaching plug for one minute and then plug it again
The water temperature is not warm enough	Check whether the water temperature switches to low level or not	Regulate the water temperature according to the Installation & User Manual
The cleansing is always leaking	Solenoid valve no longer has any effect	Please contact our Customer Service Team
The cleaning function is not working normally	The human induction system of the toilet seat no longer has any effect	Please contact our Customer Service Team

**Dryer**

Phenomenon	Fault Diagnoses	Solutions
The dryer blows cold air	Check whether the dryer switches off or not	Regulate the temperature of dryer according to the Installation & User Manual
	Check whether the heating element of dryer is damaged or not	Please contact our Customer Service Team

**Heated Seat**

Phenomenon	Fault Diagnoses	Solutions
The seat temperature is too low or is not hot	Check whether the temperature of toilet seat is on the OFF position or not	Regulate the temperature of toilet seat according to the Installation & User Manual

**Remote Control**

Phenomenon	Fault Diagnoses	Solutions
The blue light of water temperature is flickered	Low battery	Please replace a new battery
Remote control is not working	Check whether there is any water on the remote control or not	Wipe off water by dry towel

**Toilet Bowl**

Phenomenon	Fault Diagnoses	Solutions
The toilet does not flush cleanly	No power supply	Power restoration
	No water from the spout	Please contact our Customer Service Team
	No water but have the sound of flushing	Check whether the pipeline is blended or not, please keep the water supply pipeline open and smooth
	Have water all the time	Please contact our Customer Service Team if there is any unusual with the water inlet valve

# Specifications

Product Model		HOROW T38P
Product Dimensions		27.44 in (L) * 15.43 in (W) * 19.69 in (H)
Product Weight (lb.)		97 lb
Rough In Size		12 in
Seat Height		17.56 in
Bowl/Seat Shape		Elongated
Flush Type		Tornado flush
Gallons Per Flush (US gallon)		Dual Flush: 1.0/1.28
Installation Type		Floor-mount
Rated Voltage		120 V~
Rated Frequency		60 Hz
Rated Power		1050 W (When inlet water temperature is 59 °F)
Power Cord Length		35.43 in
Water Supply Type		DN15 (G1/2)
Water Inlet	Inlet Water Temperature	41 °F ~ 104 °F
	Minimum Pressure	11.6 psi, ensuring a flow of water at least 3.65 GPM
	Maximum Pressure	108 psi (static state)
Cleaning	Way for Heating	Instant Heating
	Temperature of Warm Water	Off/about 93.2 °F ~ 102.2 °F (4 levels)
	Safety Devices	Thermostat series, thermal fuse, flow detection device
Dryer	Warm Air Temperature	Off/about 95 °F ~ 131 °F (4 levels)
	Warm Air Speed	Above 4 m/s
	Safety Devices	Bimetal thermostat series, thermal fuse
Heated Seat	Seat Temperature	Off/about 93.2 °F ~ 102.2 °F (4 levels)
	Safety Devices	Thermal fuse, temperature sensor
Remote Control Battery		Two AAA batteries
Blackout Flush Battery		One lithium battery (Separate purchase required)

# Warranty

## ONE YEAR LIMITED WARRANTY

HOROW products are made with high-quality materials and workmanship to provide customers with products that are built to last. If any defects in material or workmanship are detected during normal use within the first year of purchase, such as the replacement of any product or product part that you consider to be defective, HOROW will provide replacement parts free of charge. We are **not responsible** for all damages that result from **improper installation resulting in unavailability, repair and maintenance**. This warranty applies only to the original purchaser. Proof of purchase and **evidence of damage** will be required in the case of a **claim**.

HOROW recommends the installations to be made by a licensed, professional plumber.

HOROW will not be held responsible for any damage or product failure due to improper installation, misuse, or failure to use a licensed professional. HOROW is not responsible for any removal or installation cost.

This One Year Limited Warranty will be voided if:

The installation recommendations were not followed.

The product has been moved from its initial place of installation.

The product has been modified.

The product has been subjected to improper maintenance, abuse, misuse, excessive use of chemicals, accident or other damages.

HOROW makes no implication that products comply with any or all local building or plumbing codes. It is the consumer's responsibility to determine local code compliance. This warranty extends to the original purchaser and first consumer.

HOROW is not liable for any incidental, consequential or special damages associated with the return, replacement, installation or use of your product. This includes freight costs, labor, travel time, lost profit, home damages and other contingent liabilities and costs (including, without limitation, costs associated with experts, investigations, analyses, attorneys and other professionals and services).

The HOROW warranty is a comprehensive and explicit limit of liability, and all items outside of it are not addressable by or the responsibility of HOROW. Certain states have variances regarding implied warranties and in those situations, we remain fully compliant.

### Warranty Registration

Proof of purchase is required to validate this limited warranty. HOROW encourages you to register your product upon purchase to create a record of ownership at [www.horow.com](http://www.horow.com). Registration is voluntary and not required to maintain your limited warranty rights.



**For any questions or claims, please contact us by phone or email.**

**Phone: (+1)209-200-8033**

**Monday to Friday**

**Email: [support@horow.com](mailto:support@horow.com)**

When making a claim, please prepare a photo of the evidence of damage so that we can quickly resolve the claim for you.



### Warning

Content may contain sharp and other possibly harmful pieces and may cause hazard to children and adults, HOROW is not responsible in any way for personal damage.